

---

**TOSVERT VF-S15**

---

**PID control Instruction Manual**

---

— Contents —

1. Introduction .....	2
2. PID control function .....	3
2.1. Process PID control .....	3
2.2. Speed PID control .....	5
3. Parameter list of PID control.....	7
4. Setting for PID control.....	10
4.1. Fundamental setting.....	10
4.1.1. Feedback value .....	10
4.1.2. Process value .....	11
4.1.3. Override function .....	15
4.1.4. Acceleration and deceleration time.....	15
4.2. Set to suit the motor .....	16
4.3. Set to suit the system.....	16
4.3.1. Set if necessary .....	16
4.3.2. Switch PID characteristic.....	16
4.3.3. Agreement between process and feedback value.....	17
4.3.4. Switch to frequency command operation .....	17
5. PID control adjustment .....	18
5.1. Summary of adjustment .....	18
5.2. Fundamental adjustment (common) .....	18
5.2.1. Proportional (P) gain.....	18
5.2.2. Integral (I) gain.....	19
5.2.3. Differential (D) gain .....	19
5.3. Applied adjustment (Common).....	20
5.3.1. PID integral / differential clear.....	20
5.3.2. PID control waiting time .....	20
5.4. Applied adjustment (for speed PID control) .....	21
5.4.1. Delay filter .....	21
5.4.2. Process increasing rate/ decreasing rate .....	21
6. Analog input characteristics.....	22

---

# 1. Introduction

---

VF-S15 has two types of PID control function.

You can select the type for your application.

Process PID control: The control is performed gently in response to change in temperature or pressure for fan and pump.

Speed PID control : The control is performed at high speed in response to change in speed for winder.

This manual is constructed as follows;

Chapter 2: Explanation of two types of PID control

Chapter 3: Parameter list for PID control

Chapter 4: Setting parameter for PID control

Chapter 5: Adjustment for PID control

Chapter 6: Analog input characteristics

It is necessary to convert process value and feedback value into frequency for setting.

## 2. PID control function

Select one from the two types of PID control function for your application.

### 2.1. Process PID control

Process PID control is selected for temperature or pressure control of fan and pump which is performed gently in response to change the speed.

[Process PID control (*F 360= 1*)]

[Diagram]

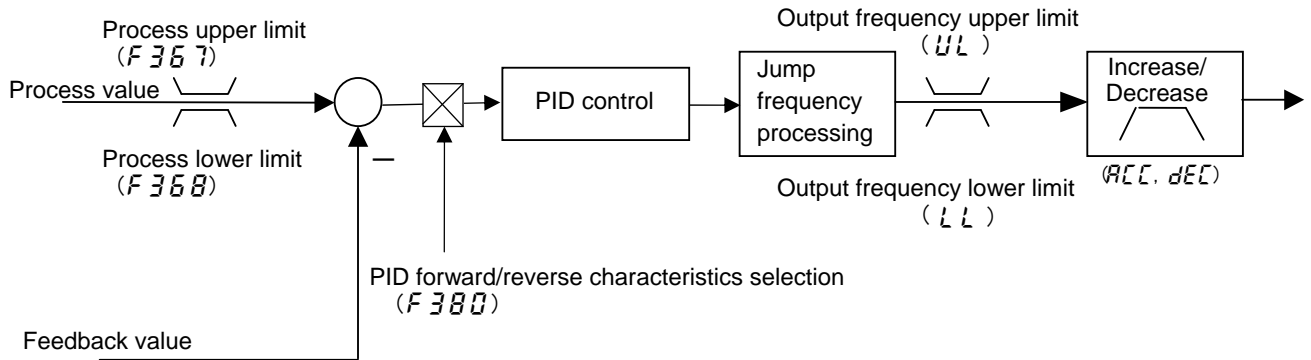

[Parameter setting]

Refer to the chapter 4 and 5 for details of parameter setting.

1) Select the input of process value and feedback value.

It is necessary to convert temperature or pressure into frequency for setting.

Item	Title	Function
Process value	<i>F 389</i>	PID control reference signal selection
	<i>F P 1d</i>	Process input value of PID control ( <i>F 389=3</i> )
Feedback value	<i>F 369</i>	PID control feedback signal selection

Frequency free unit conversion function enables to set process value and feedback value easily.

See the chapter 3 for details.

2) Set the following parameters to suit the motor if necessary.

Title	Function
<i>F H</i>	Maximum frequency
<i>U L</i>	Upper limit frequency
<i>L L</i>	Lower limit frequency
<i>F 270 to F 275</i>	Jump frequency 1 to 3
<i>F 240</i>	Starting frequency
<i>F 241</i>	Operation starting frequency

3) Set the following parameters to suit the system.

- a) Set the acceleration time and deceleration time to short for quick response within the range not to cause inverter trip.

Title	Function
<i>ACC</i>	Acceleration time 1
<i>DEC</i>	Deceleration time 1

- b) Set the following parameters if necessary.

Item	Title	Function
Limit the input level of process value.	<i>F367</i>	Process upper limit
	<i>F368</i>	Process lower limit
Switch the PID forward /reverse characteristics.	<i>F380</i>	PID forward /reverse characteristics selection
	Input terminal function: 54/55: PID characteristics switching	
Output of agreement signal between process value and feedback value.	<i>F167</i>	Frequency command agreement detection range
	Output terminal function: 144/145: Signal in accordance of frequency command	

4) Adjust the PID control gain.

Refer to chapter 5 for details.

- a) Fundamental adjustment

Item	Title	Function
PID control gain	<i>F362</i>	Proportional gain
	<i>F363</i>	Integral gain
	<i>F366</i>	Differential gain

- b) Adjust the following parameter if necessary.

Item	Title	Function
Start the PID control after the system becomes stable.	<i>F359</i>	PID control waiting time

## 2.2. Speed PID control

Speed PID control is selected for speed control of a winder to which fast response is required. Acceleration/ deceleration time is automatically set to the shortest time. It also responds much faster by controlling with the increase/ decrease rate which is separated from acceleration/ deceleration time. Delay filter is set to the feedback value for the stable operation.

### [Speed PID control (F 360=2)]

#### [Diagram]

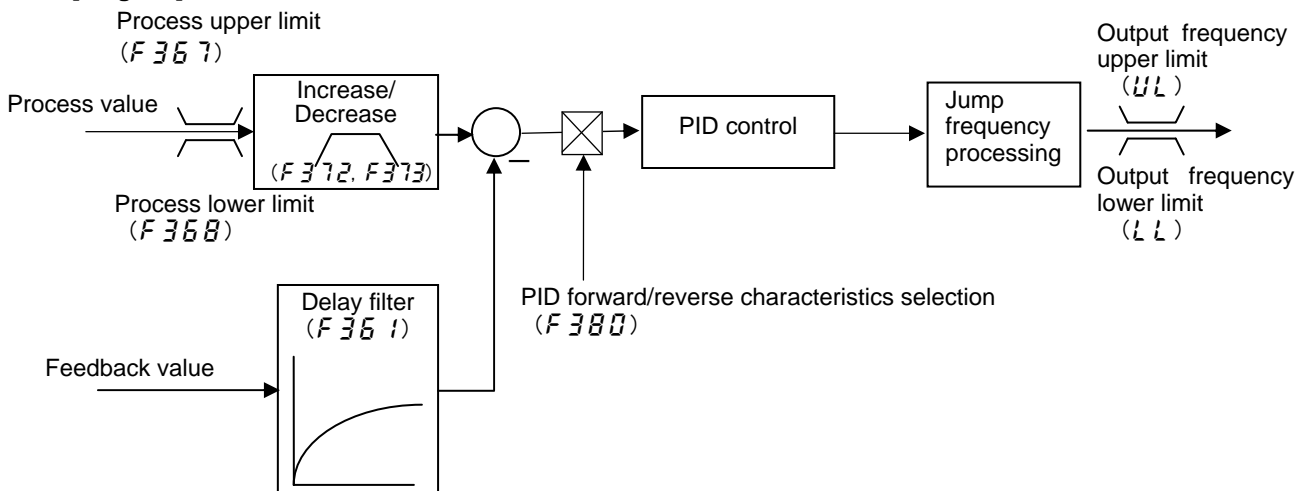

#### [Parameter setting]

Refer to the chapter 4 and 5 for details of parameter setting.

- 1) Select the input of process value and feedback value.

It is necessary to convert tension level into frequency for setting.

Item	Title	Function
Process value	F 389	PID control reference signal selection
	F P 1d	Process input value of PID control (F 389=3)
Feedback value	F 369	PID control feedback signal selection

- a) Frequency free unit conversion function enables to set process value and feedback value easily. Refer to the chapter 3 for detail.
- b) It is possible to add or multiply for process value by override function.

Item	Title	Function
Addition	F 560	Override addition input selection
Multiplication	F 561	Override multiplication input selection

- 2) Set the following parameters to suit the motor if necessary.

Title	Function
F H	Maximum frequency
U L	Upper limit frequency
L L	Lower limit frequency
F 270 to F 275	Jump frequency 1 to 3
F 240	Starting frequency
F 241	Operation starting frequency

3) Set the following parameters to suit the system.

Speed PID control set the acceleration time and the deceleration time to the smallest automatically regardless of parameter (ACC, DEC) setting. It also responds much faster by controlling with the increase/ decrease rate which is separated from acceleration/ deceleration time.

Set the following parameters if necessary.

Item	Title	Function
Limit the input level of process value.	F367	Process upper limit
	F368	Process lower limit
Output of agreement signal between process value and feedback value.	F167	Frequency command agreement detection range
	Output terminal function: 144/145: Signal in accordance of frequency command	

4) Adjust the PID control gain.

Refer to the chapter 5 for details.

a) For fundamental adjustment, adjust for stability, and quick response.

Item	Title	Function
PID control gain	F362	Proportional gain
	F363	Integral gain
	F366	Differential gain
Steady the PID control (Feedback filter)	F361	Delay filter
Adjust for quick response	F372	Process increasing rate (speed type PID control)
	F373	Process decreasing rate (speed type PID control)

b) Adjust the following parameter if necessary.

Item	Title	Function
Start the PID control after the system becomes stable.	F359	PID control waiting time

### 3. Parameter list of PID control

Title	Function	Adjustment range	Default setting
<i>F00d</i>	Frequency setting mode selection 1	0:Setting dial 1 (save even if power is off) 1: Terminal VIA 2: Terminal VIB 3: Setting dial 2 (press in center to save) 4: RS485 communication 5: UP/DOWN from external logic input 6: CANopen communication 7: Communication option 8: Terminal VIC 9,10: - 11: Pulse train input 12,13: - 14: <i>Sr0</i>	0
<i>ACC</i>	Acceleration time 1	0.0-3600 (s)	10.0
<i>dEC</i>	Deceleration time 1	0.0-3600 (s)	10.0
<i>FH</i>	Maximum frequency	30.0-500.0 (Hz)	80.0
<i>UL</i>	Upper limit frequency	0.5- <i>FH</i> (Hz)	*1
<i>LL</i>	Lower limit frequency	0.0- <i>UL</i> (Hz)	0.0
<i>Sr1</i> to <i>Sr7</i>	Preset-speed frequency 1 to 7	<i>LL</i> - <i>UL</i> (Hz)	0.0
<i>FP1d</i>	Process input value of PID control	<i>F358</i> - <i>F357</i> (Hz)	0.0
<i>F157</i>	Frequency command agreement detection range	0.0- <i>FH</i> (Hz)	2.5
<i>F201</i>	VIA input point 1 setting	0-100(%)	0
<i>F202</i>	VIA input point 1 frequency	0.0-500.0(Hz)	0.0
<i>F203</i>	VIA input point 2 setting	0-100(%)	100
<i>F204</i>	VIA input point 2 frequency	0.0-500.0(Hz)	*1
<i>F207</i>	Frequency setting mode selection 2	0-14 (Same as <i>F00d</i> )	1
<i>F210</i>	VIB input point 1 setting	-100+100(%)	0
<i>F211</i>	VIB input point 1 frequency	0.0-500.0(Hz)	0.0
<i>F212</i>	VIB input point 2 setting	-100+100(%)	100
<i>F213</i>	VIB input point 2 frequency	0.0-500.0(Hz)	*1
<i>F216</i>	VIC input point 1 setting	0-100(%)	20
<i>F217</i>	VIC input point 1 frequency	0.0-500.0(Hz)	0.0
<i>F218</i>	VIC input point 2 setting	0-100(%)	100
<i>F219</i>	VIC input point 2 frequency	0.0-500.0(Hz)	*1
<i>F240</i>	Starting frequency	0.1-10.0 (Hz)	0.5
<i>F241</i>	Operation starting frequency	0.0- <i>FH</i> (Hz)	0.0
<i>F270</i>	Jump frequency 1	0.0- <i>FH</i> (Hz)	0.0
<i>F271</i>	Jumping width 1	0.0-30.0 (Hz)	0.0
<i>F272</i>	Jump frequency 2	0.0- <i>FH</i> (Hz)	0.0
<i>F273</i>	Jumping width 2	0.0-30.0 (Hz)	0.0
<i>F274</i>	Jump frequency 3	0.0- <i>FH</i> (Hz)	0.0
<i>F275</i>	Jumping width 3	0.0-30.0 (Hz)	0.0
<i>F359</i>	PID control waiting time	0-2400 (s)	0
<i>F360</i>	PID control	0: Disabled 1: Process type PID control 2: Speed type PID control	0
<i>F361</i>	Delay filter	0.0-25.0 (s)	0.1
<i>F362</i>	Proportional gain	0.01-100.0 (s)	0.30



<i>F363</i>	Integral gain	0.01-100.0 (s <sup>-1</sup> )	0.20
<i>F366</i>	Differential gain	0.00-2.55 (s)	0.00
<i>F367</i>	Process upper limit	0.0- <i>FH</i> (Hz)	*1
<i>F368</i>	Process lower limit	0.0- <i>F367</i> (Hz)	0.0
<i>F369</i>	PID control feedback signal selection	0:Disabled 1: Terminal VIA 2: Terminal VIB 3: Terminal VIC 4 to 6: -	0
<i>F372</i>	Process increasing rate (speed type PID control)	0.1-600.0 (s)	10.0
<i>F373</i>	Process decreasing rate (speed type PID control)	0.1-600.0 (s)	10.0
<i>F380</i>	PID forward /reverse characteristics selection	0:Forward 1:Reverse	0
<i>F389</i>	PID control reference signal selection	0: <i>F00d</i> / <i>F207</i> selected 1: Terminal VIA 2: Terminal VIB 3: <i>FPId</i> 4: RS485 communication 5: UP/DOWN from external logic input 6: CANopen communication 7: Communication option 8: Terminal VIC 9,10: - 11: Pulse train input	0
<i>F660</i>	Override addition input selection	0:Disabled 1: Terminal VIA 2: Terminal VIB 3: Terminal VIC 4: <i>FL</i>	0
<i>F661</i>	Override multiplication input selection	0:Disabled 1: Terminal VIA 2: Terminal VIB 3: Terminal VIC 4: <i>F729</i>	0
<i>F702</i>	Frequency free unit display magnification	0.00:Disabled (display of frequency) 0.01-200.0(times)	0.00
<i>F703</i>	Frequency free unit coverage selection	0: All frequencies display 1: PID frequencies display	0
<i>F729</i>	Operation panel override multiplication gain	-100-+100 (%)	0

\*1: Default setting values vary depending on the setup menu setting.

[Input /Output terminal function]

	Positive logic	Negative logic	Function
Input terminal	36	37	PID control prohibition
	52	53	PID integral / differential clear
	54	55	PID characteristics switching
Output terminal	144	145	Signal in accordance of frequency command

[FM/ pulse output and monitor output function]

FM/ Pulse output		Monitor output		Function
Option No.	Communication No.	Option No.	Communication No.	
2	FD02	2	FE02	Frequency setting value
23	FD22	23	FE22	PID feedback value

You need to convert the process value and the feedback value into frequency for the PID control. *F 702* (Frequency free unit display magnification) and *F 703* (Frequency free unit coverage selection) enable to set process value and feedback value easily. The functions convert frequency display to temperature or pressure level by calculation.

$$\boxed{\text{Value displayed}} = \boxed{\text{Frequency displayed on the monitor or specified with a parameter}} \times \boxed{F 702}$$

*F 703 = 0*

Frequency on the monitor or specified with parameter is displayed by the value multiplied by *F 702*.

Note) This setting does not change automatically if you switch from PID control to frequency command operation. Output frequency is displayed by the value by *F 702*.

*F 703 = 1*

Frequency of the following parameters and the frequency on the monitor are displayed by the value multiplied by *F 702*

[Parameters]

Title	Function
<i>FP 1d</i>	Process input value of PID control
<i>F 367</i>	Process upper limit
<i>F 368</i>	Process lower limit

[FM/ pulse output and monitor display]

FM/ Pulse output		Monitor output		Function
Option No.	Communication No.	Option No.	Communication No.	
2	FD02	2	FE02	Frequency setting value
23	FD22	23	FE22	PID feedback value

## 4. Setting for PID control

First, set the process value and feedback value. : 4.1

Then, set other parameters to suit the motor and the system if necessary. : 4.2, 4.3

Note) Set process value and feedback value by converting each pressure level into frequency.

Actual output frequency is different from setting frequency for PID control.

### 4.1. Fundamental setting

Make sure to set the process value and the feedback value.

In case of process type PID control, you need to set acceleration time and deceleration time to short for quick response.

#### 4.1.1. Feedback value

Input the signal from detector as feedback signal.

1. Select the feedback signal at *F 3 6 9*.

Description	PID control feedback signal selection ( <i>F 3 6 9</i> )
Disabled	0
Terminal VIA	1
Terminal VIB	2
Terminal VIC	3

2. Set feedback value after converting the feedback input level into frequency.

- 1) Analog input

Refer to the chapter 6 for details of analog input characteristic setting.

**[Example of feedback setting]**

Condition: Pressure control as PID control.

Input the feedback signal of 1 to 2 atm into VIC terminal by 4 to 20mA signal.

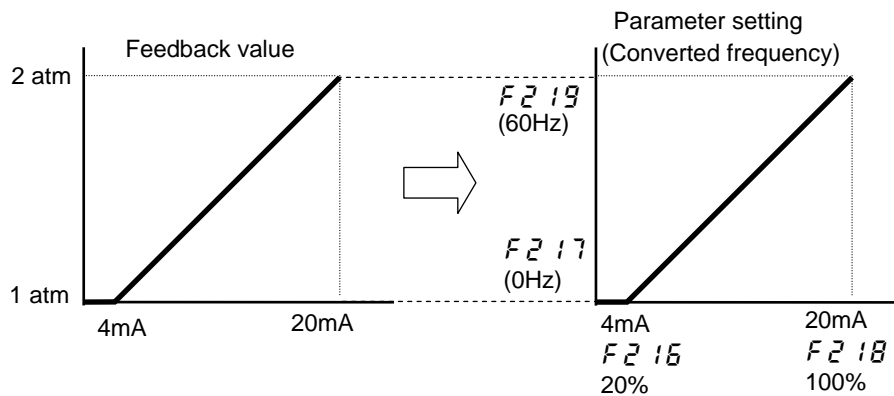

It is possible to set or switch the forward/ reverse characteristics.

a) Example of setting reverse characteristic

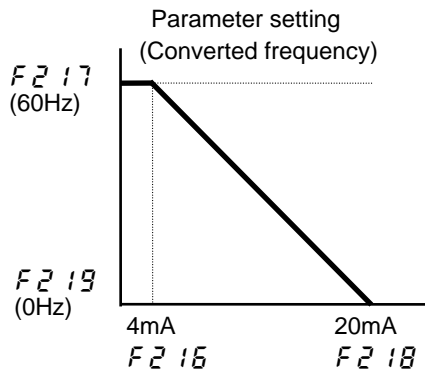

b) Example of switching characteristic by S3 input terminal (positive logic)

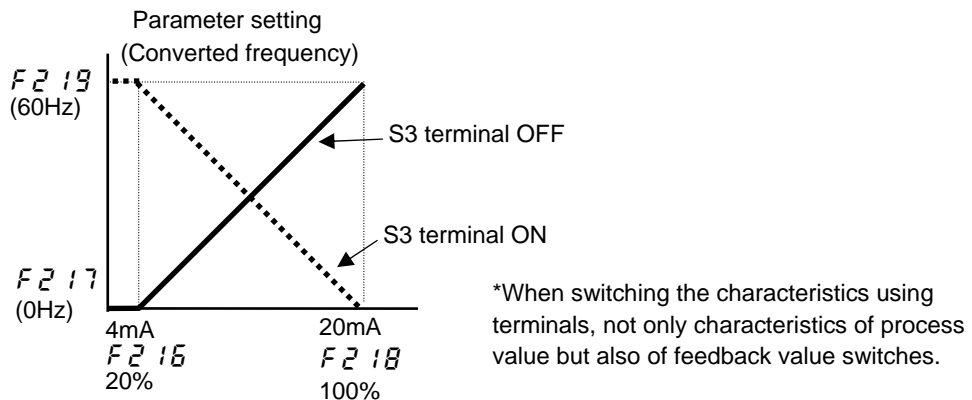

Title	Function	Example of setting
<i>F 1 1 5</i>	Input terminal selection 6 (S3)	54: PID characteristics switching
<i>F 2 1 6</i>	VIC input point 1 setting	20(%)
<i>F 2 1 7</i>	VIC input point 1 frequency	0(Hz)
<i>F 2 1 8</i>	VIC input point 2 setting	100(%)
<i>F 2 1 9</i>	VIC input point 2 frequency	60(Hz)

## 4.1.2. Process value

Input the target value in relation to the feedback value as process value.

1. Select the process signal at *F 3 8 9*.

Description	PID control reference signal selection ( <i>F 3 8 9</i> )
<i>F 0 0 4</i> / <i>F 2 0 7</i> selected	0
Terminal VIA	1
Terminal VIB	2
<i>F P 1 d</i>	3
RS485 communication	4
UP/DOWN from external logic input	5
CANopen communication	6
Communication option	7
Terminal VIC	8
Pulse train input	11

It is possible to add or multiply for process value by override function.

2. Perform the setting of feedback input level after converting it into frequency.

<Note>  
 Input process value needs to be less than maximum feedback value.  
 If the input process value is same as maximum feedback value or more, the deviation becomes zero when the feedback value reaches maximum. The output frequency is fixed even though actual output becomes even more higher, because the feedback value will not exceed maximum.  
 Upper limit of process value input can be set by parameter *F357*: Process upper limit.

1) *FP1d* setting

**[Example of process value setting]**

Condition: Pressure control as PID control.

Input the feedback signal of 1 to 2 atm into terminal VIC by 4 to 20mA signal.  
 Input the process value by *FP1d* setting.

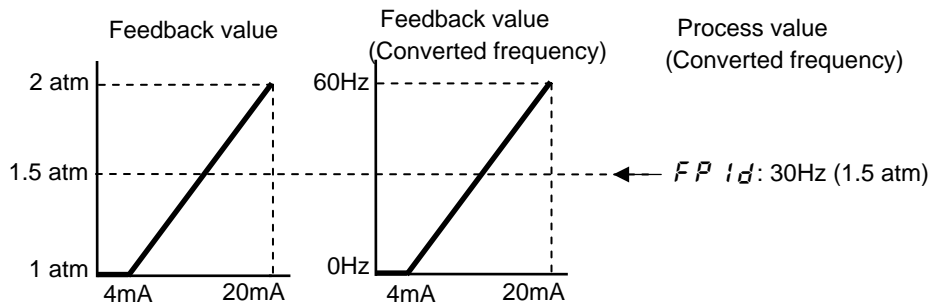

Title	Function	Setting (Example)
<i>FP1d</i>	Process input value of PID control	30(Hz)
<i>F216</i>	VIC input point 1 setting	20(%)
<i>F217</i>	VIC input point 1 frequency	0(Hz)
<i>F218</i>	VIC input point 2 setting	100(%)
<i>F219</i>	VIC input point 2 frequency	60(Hz)
<i>F389</i>	PID control reference signal selection	3: <i>FP1d</i>

Note 1) Value of *FP1d* can be set or changed during operation with the use of setting dial, and then saved in *FP1d*.

Note 2) Input process value needs to be less than maximum feedback value.

2) Analog input

Refer to the chapter 6 for detail of analog input characteristic setting.

**[Example of process value setting]**

Condition: Pressure control as PID control.

Input the feedback signal of 1 to 2 atm into Terminal VIC by 4 to 20mA signal.  
 Input the process value into Terminal VIB by 0 to 10V signal.

[Example of system]

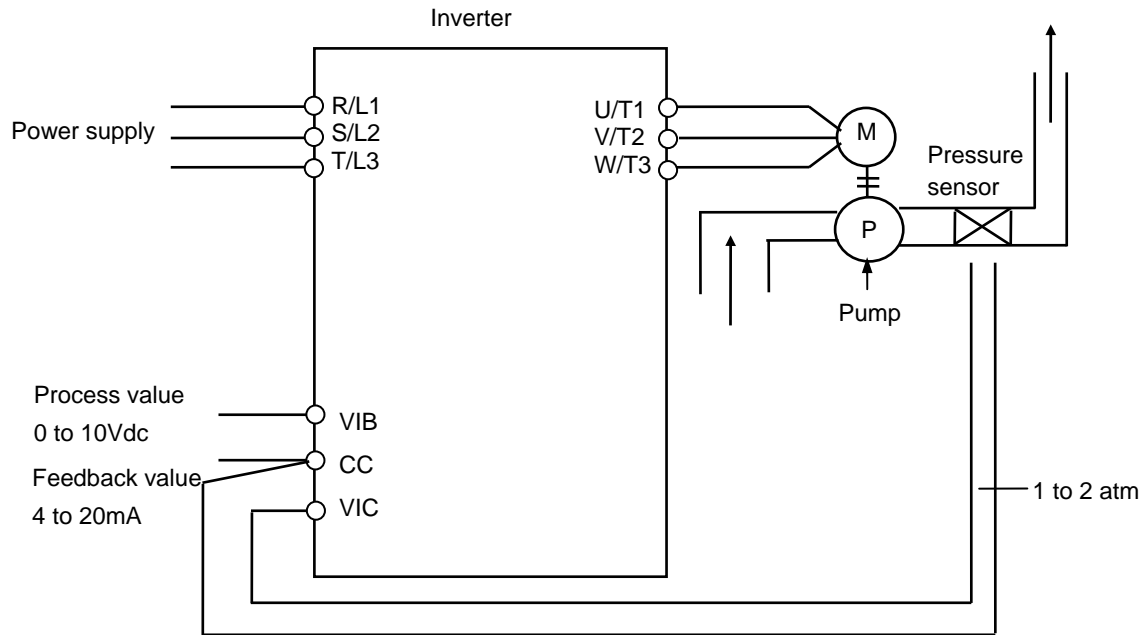

[Parameter setting]

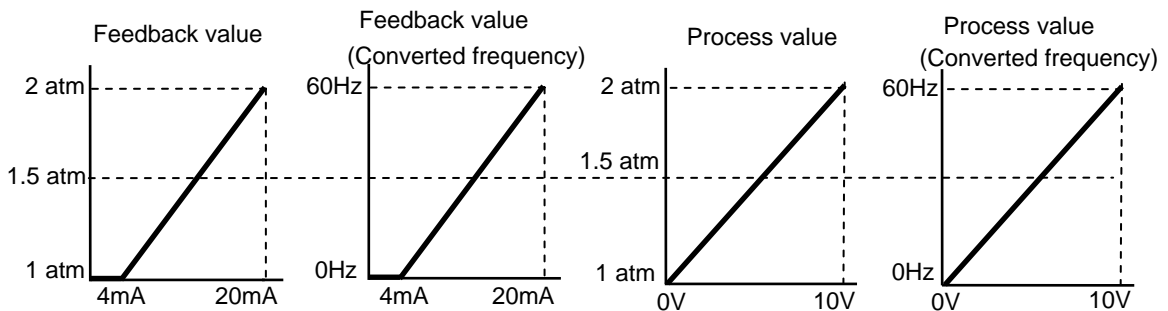

Pressure (atm)	Feedback value (4-20mA)	Process value (0-10V)	Converted frequency (Hz)
1	4	0	0
1.25	8	2.5	15
1.5	12	5.0	30
1.75	16	7.5	45
2	20	10	60

Convert the pressure feedback value and pressure process value into frequency.

Actual output frequency is, regardless of the converted frequency, the output frequency as a result of PID control.

<Note>

Input process value needs to be less than maximum feedback value.

If the process value is 2 atm=10V (60Hz), the deviation becomes zero when the feedback value reaches 2 atm=20mA (60Hz). The output frequency is fixed even though actual output becomes even more higher, because the feedback value will not exceed over 20mA (60Hz).

Title	Function	Setting (Example)
<i>F 107</i>	Analog input terminal selection (VIB)	0:0-+10V
<i>F 210</i>	VIB input point 1 setting	0(%)
<i>F 211</i>	VIB input point 1 frequency	0(Hz)
<i>F 212</i>	VIB input point 2 setting	100(%)
<i>F 213</i>	VIB input point 2 frequency	60(Hz)
<i>F 215</i>	VIC input point 1 setting	20(%)
<i>F 217</i>	VIC input point 1 frequency	0(Hz)
<i>F 218</i>	VIC input point 2 setting	100(%)
<i>F 219</i>	VIC input point 2 frequency	60(Hz)
<i>F 389</i>	PID control reference signal selection	2: Terminal VIB

### 3) Preset speed

#### [Example of process value setting]

Condition: Pressure control as PID control.

Input the feedback signal of 1 to 2 atm into Terminal VIC by 4 to 20mA signal.

Input the process value into Terminals S1 and S2 by preset speed 1, 2, and 3 settings.

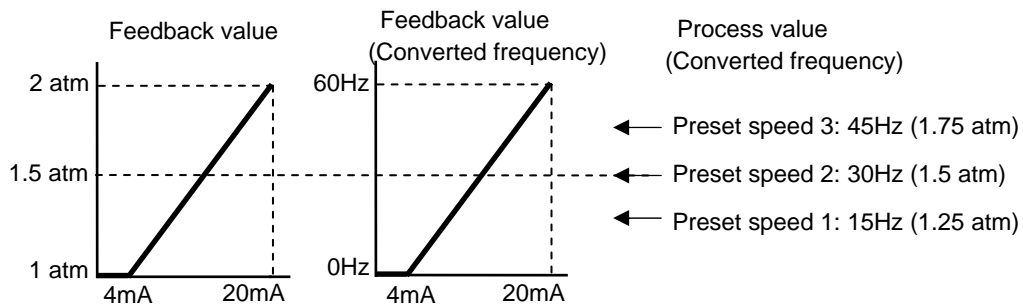

Pressure (atm)	Feedback value (4-20mA)	Process value			Converted frequency (Hz)
		Preset speed 1 to 3	S1 terminal	S2 terminal	
1	4	-	-	-	0
1.25	8	1	ON	OFF	15
1.5	12	2	OFF	ON	30
1.75	16	3	ON	ON	45
2	20	-	-	-	60

Title	Function	Setting (Example)
<i>Sr 1</i>	Preset speed frequency 1	15(Hz)
<i>Sr 2</i>	Preset speed frequency 2	30(Hz)
<i>Sr 3</i>	Preset speed frequency 3	45(Hz)
<i>F 114</i>	Input terminal selection 4A (S1)	10: Preset speed 1
<i>F 115</i>	Input terminal selection 5 (S2)	12: Preset speed 2
<i>F 215</i>	VIC input point 1 setting	20(%)
<i>F 217</i>	VIC input point 1 frequency	0(Hz)
<i>F 218</i>	VIC input point 2 setting	100(%)
<i>F 219</i>	VIC input point 2 frequency	60(Hz)

Note) Input process value needs to be less than maximum feedback value.

---

## 4.1.3. Override function

---

### Speed type

Override functions ( $F660$ ,  $F661$ ) enable to add or multiply for fine adjustment of process value.

It is possible to set multiplication gain by analog input or parameter  $F729$ .

Refer to the inverter instruction manual for the detail of the setting.

\* This function is valid also for process type PID, but it is rarely used.

---

## 4.1.4. Acceleration and deceleration time

---

### Process type

Set the acceleration time ( $AEL$ ) and deceleration time ( $DEL$ ) to short for quick response.

But excessively small setting causes inverter trip.

### Speed type

Speed PID control set the acceleration time and the deceleration time to the smallest automatically regardless of parameter ( $AEL$ ,  $DEL$ ) setting

\* Adjust each gain in case that the inverter trips. If you need to extend acceleration time and the deceleration time, select the process type PID control.



## 4.2. Set to suit the motor

Set only the parameters necessary for the motors.

These parameters are valid for actual output frequency as a result of PID control.

Title	Function	Description
<i>FH</i>	Maximum frequency	1) Set the maximum frequency of the output frequency. 2) This is the basis of the acceleration time ( <i>ACC</i> ) and deceleration time ( <i>DEC</i> ). Acceleration time ( <i>ACC</i> ): time from 0Hz to <i>FH</i> . Deceleration time ( <i>DEC</i> ): time from <i>FH</i> to 0Hz.
<i>UL</i>	Upper limit frequency	This is the upper limit of output frequency.
<i>LL</i>	Lower limit frequency	This is the lower limit of output frequency.
<i>F270</i> to <i>F275</i>	Jump frequency 1 to 3	Set the jump frequency to avoid (jump) resonance of the machinery.
<i>F240</i>	Starting frequency	1) The inverter outputs frequency of <i>F240</i> immediately. 2) It is useful for quick response of starting torque.
<i>F241</i>	Operation starting frequency	The inverter operates (Run/Stop) by <i>F241</i> setting frequency

Note) Note that the inverter may run and stop frequently when setting large value for *F241*.

## 4.3. Set to suit the system

### 4.3.1. Set if necessary

Set the following parameters if necessary.

Title	Function	Description
<i>F367</i>	Process upper limit	1) This is upper limit of process value. 2) If the process value exceeds the upper limit of feedback value, the output frequency is fixed. (Refer to 4.2.1 for details.) Set the upper limit of process value when it is difficult to adjust by the input level of process value.
<i>F368</i>	Process lower limit	This is lower limit of process value.

### 4.3.2. Switch PID characteristics

You can set and switch the PID forward / reverse characteristics.

It is useful for process type PID control including hot / cool switching of temperature control.

Title	Function	Description
<i>F380</i>	PID forward /reverse characteristics selection	You can select the PID forward / reverse characteristics. You can switch the characteristics of process value and feedback value by the input signal.

[Input terminal function]

Positive logic	Negative logic	Function	Description (Positive logic)
54	55	PID characteristics switching	Switch the PID forward / reverse characteristics of the process value and the feedback value.

### 4.3.3. Agreement between process and feedback value

It is possible to output agreement signal between the process value and the feedback value. Signal is output when the frequency command value by *F 389* and the feedback value by *F 369* are within  $\pm F 157$ .

Title	Function	Description
<i>F 157</i>	Frequency command agreement detection range	Set the PID frequency command agreement detection range. 0.0~ <i>F H</i> (Hz)

[Output terminal function]

Positive logic	Negative logic	Function	Description (Positive logic)
144	145	Signal in accordance of frequency command	Frequency command by <i>F 389</i> and <i>F 369</i> are within $\pm F 157$ .

### 4.3.4. Switch to frequency command operation

You can switch from PID control to frequency command operation by input terminal signal. The inverter operates with the frequency set by frequency setting mode selection *F 104* (or *F 207*).

Process type

The acceleration time and the deceleration time are set small for quick response of the PID control. You can use the second acceleration time and deceleration time if necessary.

[Input terminal function]

Positive logic	Negative logic	Function	Description (Positive logic)
36	37	PID control prohibition	Switch to frequency command operation after PID control is OFF

## 5. PID control adjustment

### 5.1. Summary of adjustment

<In case with the estimate of PID gain>

- Set the estimated value of PID gain and check the operation of the system.
- Adjust the gain if necessary.

<In case without the estimate of PID gain>

- 1) First, operate the inverter by default setting gain and check the operation of the system.
- 2) Adjust the fundamental gain.
  - (1) Adjust the proportional (P) gain if the response is delayed.
  - (2) Adjust the integral (I) gain if the unstable condition continues.
  - (3) Adjust the differential (D) gain if the system always changes or continues unstable condition even after PI gain adjustment.
- 3) Apply further adjustment for stability if necessary.
  - \* Adjust the delay filter to stabilize the speed PID control.

### 5.2. Fundamental adjustment (common)

The fundamental gain of PID control adjusted according to the system.

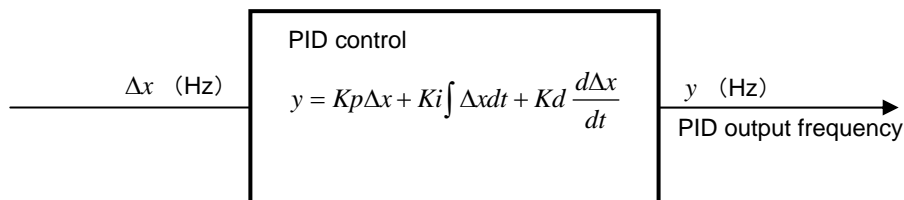

Symbol	Title	Function	Set value
$K_p$	F 362	Proportional gain	F 362=1.0: $K_p=1.0$
$K_i$	F 363	Integral gain	F 363=1.0: $K_i=1.0 \text{ (s}^{-1}\text{)}$
$K_d$	F 366	Differential gain	F 366=1.0: $K_d=1.0 \text{ (s)}$

#### 5.2.1. Proportional (P) gain

Set the proportional (P) gain of PID control by F 362.

The proportional (P) gain, a factor gained by multiplying the deviation (difference between the process value and the feedback value), is used to perform control so as to make a correction in proportion to the deviation. Although larger gain is effective for quicker response, excessively high gain may cause an unstable operation including vibration.

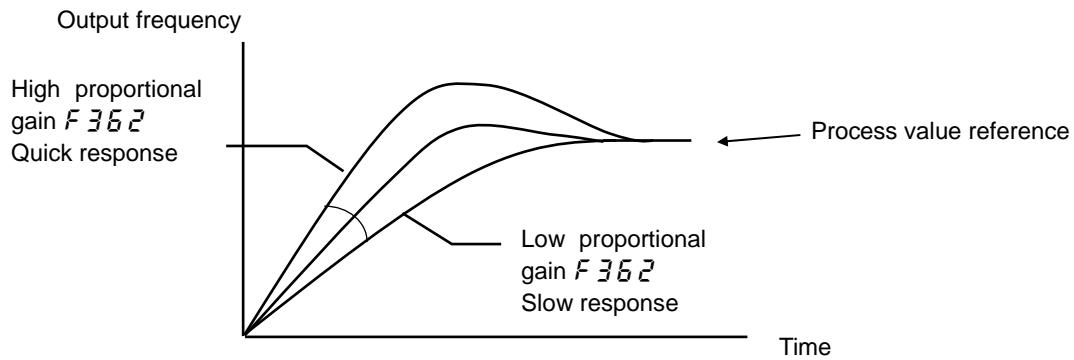

### 5.2.2. Integral (I) gain

Set the integral (I) gain of PID control by *F 363*.

The integral gain reduces the deviation remaining after proportional control (residual deviation offset) to zero.

Although larger gain reduces the residual deviation, excessively high gain may cause an unstable operation including vibration.

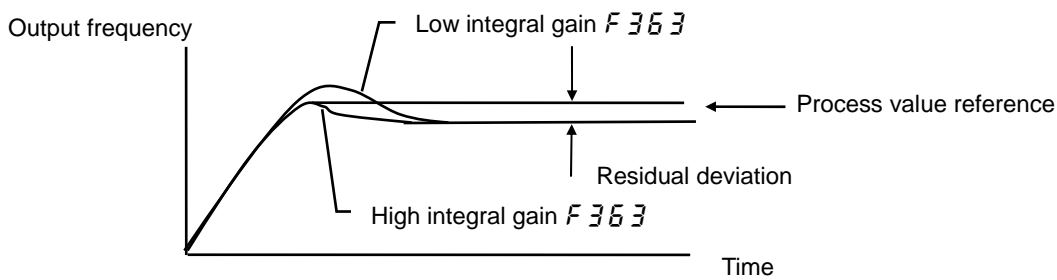

### 5.2.3. Differential (D) gain

Set the differential (D) gain of PID control by *F 365*.

The differential gain increases the response speed in case of radical change in deviation.

However, excessively high gain may cause instability including considerable fluctuations of output frequency.

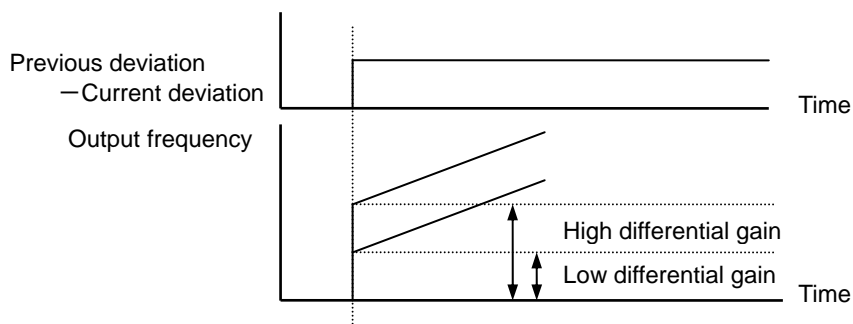

## 5.3. Applied adjustment (Common)

Make the following adjustments for increasing stability if necessary.

### 5.3.1. PID integral / differential clear

You can reset the PID integral value and differential value by input terminal signal.

[Input terminal function]

Positive logic	Negative logic	Function	Description (Positive logic)
52	53	PID integral/ differential clear	Reset the PID integral value and differential value.

### 5.3.2. PID control waiting time

You can set the waiting time to prevent PID control from starting before the system becomes stable.

Title	Function	Description
<i>F359</i>	PID control waiting time	Inverter operates with frequency set by frequency setting mode selection <i>F00d</i> (or <i>F207</i> ) within <i>F359</i> setting time. After <i>F359</i> setting time has elapsed, switch the PID control mode.

## 5.4. Applied adjustment (for speed PID control)

Adjust the following for stability of speed PID control if necessary.

### 5.4.1. Delay filter

The delay filter set with  $F361$  moderates radical change in deviation (primary delay control) to stabilize the system.

Processing speed increases with the smaller setting value and decreases with the larger setting value. (It is not necessary to change under normal conditions.)

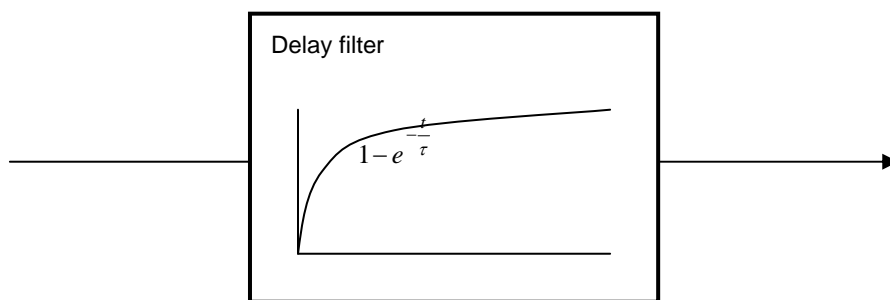

Symbol	Title	Function	Setting value
$\tau$	$F361$	Delay filter	$F361=1.0: \tau=1.0$ (s)

### 5.4.2. Process increasing rate/ decreasing rate

Process increasing rate/ decreasing rate ( $F372/F373$ ) determine the response of feedback value. Set the  $F372$  and  $F373$  to short for quick response.

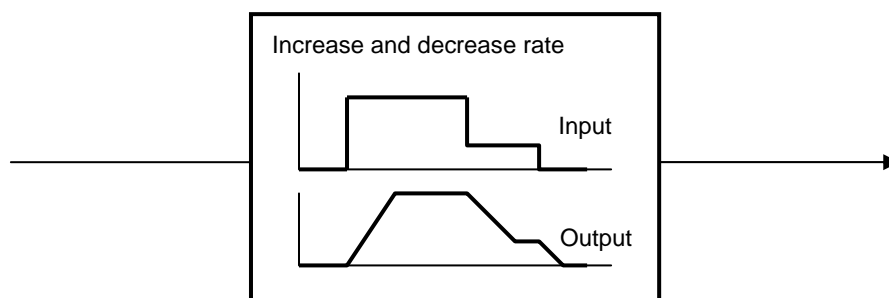

Symbol	Title	Setting value
$F372$	Process increasing rate (speed type PID control)	$F372=1.0$ : Increase reference from 0Hz to $FH$ (Maximum frequency) in 1.0 sec
$F373$	Process decreasing rate (speed type PID control)	$F373=1.0$ : Decrease reference from $FH$ (Maximum frequency) to 0Hz in 1.0 sec

## 6. Analog input characteristics

Set the analog input characteristics in case inputting the feedback value and the process value by the analog input terminals.

\*The following examples are setting from 0 to 60Hz

